

RP55

MODELING GUITAR PROCESSOR

DigiTech
by HARMAN



Owner's Manual



CAUTION

RISK OF ELECTRIC SHOCK
DO NOT OPEN



ATTENTION: RISQUE DE CHOC ELECTRIQUE - NE PAS OUVRIR

WARNING: TO REDUCE THE RISK OF FIRE OR ELECTRIC SHOCK DO NOT EXPOSE THIS EQUIPMENT TO RAIN OR MOISTURE

The symbols shown above are internationally accepted symbols that warn of potential hazards with electrical products. The lightning flash with arrowpoint in an equilateral triangle means that there are dangerous voltages present within the unit. The exclamation point in an equilateral triangle indicates that it is necessary for the user to refer to the owner's manual.

These symbols warn that there are no user serviceable parts inside the unit. Do not open the unit. Do not attempt to service the unit yourself. Refer all servicing to qualified personnel. Opening the chassis for any reason will void the manufacturer's warranty. Do not get the unit wet. If liquid is spilled on the unit, shut it off immediately and take it to a dealer for service. Disconnect the unit during storms to prevent damage.

ELECTROMAGNETIC COMPATIBILITY

This device complies with part 15 of the FCC Rules and the Product Specifications noted on the **Declaration of Conformity**. Operation is subject to the following two conditions:

- this device may not cause harmful interference, and
- this device must accept any interference received, including interference that may cause undesired operation.

Operation of this unit within significant electromagnetic fields should be avoided.

- use only shielded interconnecting cables.

U.K. MAINS PLUG WARNING

A molded mains plug that has been cut off from the cord is unsafe. Discard the mains plug at a suitable disposal facility.

NEVER UNDER ANY CIRCUMSTANCES SHOULD YOU INSERT A DAMAGED OR CUT MAINS PLUG INTO A 13 AMP POWER SOCKET.

Do not use the mains plug without the fuse cover in place. Replacement fuse covers can be obtained from your local retailer. Replacement fuses are 13 amps and MUST be ASTA approved to BS1362.

DECLARATION OF CONFORMITY

Manufacturer's Name: Digitech
Manufacturer's Address: 8760 S. Sandy Parkway
Sandy, Utah 84070, USA

declares that the product:

Product name: RP 55
Product option: all (requires Class II power adapter that conforms to the requirements of EN60065, EN60742, or equivalent.)

conforms to the following Product Specifications:

Safety: IEC 60065-01+Amd 1
EMC: EN 55022:2006
EN 55024:1998
FCC Part 15

Supplementary Information:

The product herewith complies with the requirements of the:
Low Voltage Directive 2006/95/EC
EMC Directive 2004/108/EC
RoHS Directive 2002/95/EC
WEEE Directive 2002/96/EC
EC Regulation 1275/2008

With regard to Directive 2005/32/EC and of 17 December 2008, this product is designed, produced, and classified as Professional Audio Equipment and thus is exempt from this Directive

Roger Johnson
Director, Engineering
Signal Processing
8760 S. Sandy Parkway
Sandy, Utah 84070, USA
Date: April 28, 2011

European Contact: Your local Digitech Sales and Service Office or

Harman Music Group
8760 South Sandy Parkway
Sandy, Utah
84070 USA
Ph: (801) 566-8800
Fax: (801) 568-7583



If you want to dispose this product, do not mix it with general household waste. There is a separate collection system for used electronic products in accordance with legislation that requires proper treatment, recovery and recycling.

Private household in the 25 member states of the EU, in Switzerland and Norway may return their used electronic products free of charge to designated collection facilities or to a retailer (if you purchase a similar new one).

For Countries not mentioned above, please contact your local authorities for a correct method of disposal.

By doing so you will ensure that your disposed product undergoes the necessary treatment, recovery and recycling and thus prevent potential negative effects on the environment and human health.

WARNING FOR YOUR PROTECTION

READ THE FOLLOWING:

KEEP THESE INSTRUCTIONS

HEED ALL WARNINGS

FOLLOW ALL INSTRUCTIONS

THE APPARATUS SHALL NOT BE EXPOSED TO DRIPPING OR SPLASHING LIQUID AND NO OBJECT FILLED WITH LIQUID, SUCH AS VASES, SHALL BE PLACED ON THE APPARATUS

CLEAN ONLY WITH A DRY CLOTH.

DO NOT BLOCK ANY OF THE VENTILATION OPENINGS. INSTALL IN ACCORDANCE WITH THE MANUFACTURER'S INSTRUCTIONS.

DO NOT INSTALL NEAR ANY HEAT SOURCES SUCH AS RADIATORS, HEAT REGISTERS, STOVES, OR OTHER APPARATUS (INCLUDING AMPLIFIERS) THAT PRODUCE HEAT.

ONLY USE ATTACHMENTS/ACCESSORIES SPECIFIED BY THE MANUFACTURER.

UNPLUG THIS APPARATUS DURING LIGHTNING STORMS OR WHEN UNUSED FOR LONG PERIODS OF TIME.

Do not defeat the safety purpose of the polarized or grounding-type plug. A polarized plug has two blades with one wider than the other. A grounding type plug has two blades and a third grounding prong. The wide blade or third prong are provided for your safety. If the provided plug does not fit your outlet, consult an electrician for replacement of the obsolete outlet.

Protect the power cord from being walked on or pinched particularly at plugs, convenience receptacles, and the point where they exit from the apparatus.

Refer all servicing to qualified service personnel. Servicing is required when the apparatus has been damaged in any way, such as power-supply cord or plug is damaged, liquid has been spilled or objects have fallen into the apparatus, the apparatus has been exposed to rain or moisture, does not operate normally, or has been dropped.

MAINS DISCONNECT: The plug shall remain readily operable. For rack-mount or installation where plug is not accessible, an all-pole mains switch with a contact separation of at least 3 mm in each pole shall be incorporated into the electrical installation of the rack or building.

SAFETY INSTRUCTIONS

NOTICE FOR CUSTOMERS IF YOUR UNIT IS EQUIPPED WITH A POWER CORD.

WARNING: THIS APPLIANCE SHALL BE CONNECTED TO A MAINS SOCKET OUTLET WITH A PROTECTIVE EARTHING CONNECTION.

The cores in the mains lead are coloured in accordance with the following code:

GREEN and YELLOW - Earth BLUE - Neutral BROWN - Live

As colours of the cores in the mains lead of this appliance may not correspond with the coloured markings identifying the terminals in your plug, proceed as follows:

- The core which is coloured green and yellow must be connected to the terminal in the plug marked with the letter E, or with the earth symbol, or coloured green, or green and yellow.
- The core which is coloured blue must be connected to the terminal marked N or coloured black.
- The core which is coloured brown must be connected to the terminal marked L or coloured red.

This equipment may require the use of a different line cord, attachment plug, or both, depending on the available power source of installation. If the attachment plug needs to be changed, refer servicing to qualified service personnel who should refer to the table below. The green/yellow wire shall be connected directly to the units chassis.

CONDUCTOR	WIRE COLOR	
	Normal	All
L	LIVE	BROWN BLACK
N	NEUTRAL	BLUE WHITE
E	EARTH GND	GREEN/ YEL GREEN

WARNING: If the ground is defeated, certain fault conditions in the unit or in the system to which it is connected can result in full line voltage between chassis and earth ground. Severe injury or death can then result if the chassis and earth ground are touched simultaneously.

Warranty

We at DigiTech are very proud of our products and back-up each one we sell with the following warranty:

1. Please register online at www.digitech.com within ten days of purchase to validate this warranty.
2. DigiTech warrants this product, when used solely within the U.S., to be free from defects in materials and workmanship under normal use and service.
3. DigiTech liability under this warranty is limited to repairing or replacing defective materials that show evidence of defect, provided the product is returned to DigiTech WITH RETURN AUTHORIZATION, where all parts and labor will be covered up to a period of one year. A Return Authorization number may be obtained from DigiTech by telephone. The company shall not be liable for any consequential damage as a result of the product's use in any circuit or assembly.
4. Proof-of-purchase is considered to be the burden of the consumer.
5. DigiTech reserves the right to make changes in design, or make additions to, or improvements upon this product without incurring any obligation to install the same on products previously manufactured.
6. The consumer forfeits the benefits of this warranty if the product's main assembly is opened and tampered with by anyone other than a certified DigiTech technician or, if the product is used with AC voltages outside of the range suggested by the manufacturer.
7. The foregoing is in lieu of all other warranties, expressed or implied, and DigiTech neither assumes nor authorizes any person to assume any obligation or liability in connection with the sale of this product. In no event shall DigiTech or its dealers be liable for special or consequential damages or from any delay in the performance of this warranty due to causes beyond their control.

NOTE:The information contained in this manual is subject to change at any time without notification. Some information contained in this manual may also be inaccurate due to undocumented changes in the product or operating system since this version of the manual was completed. The information contained in this version of the owner's manual supersedes all previous versions.

Introduction

Thanks to the continuous advances in musical technology, the RP55 offers you the flexibility, power, and capability of producing sonic creations never before thought possible. We recommend that you become better acquainted with us, and what we have to offer by going through this Owner's manual with your RP55 in front of you. It is your key to unlocking the potential within the RP55.

Included Items

Before you get started, please make sure that the following items have been included:

- **RP55**
- **Online Warranty Registration Information Card**

The utmost care was taken while your RP55 was being manufactured. Everything should be included and in perfect working order. If anything is missing, contact the factory at once. Please help us become acquainted with you and your needs by registering online at <http://www.digitech.com>.

It is your safeguard should a problem arise with your RP55.

The Front Panel

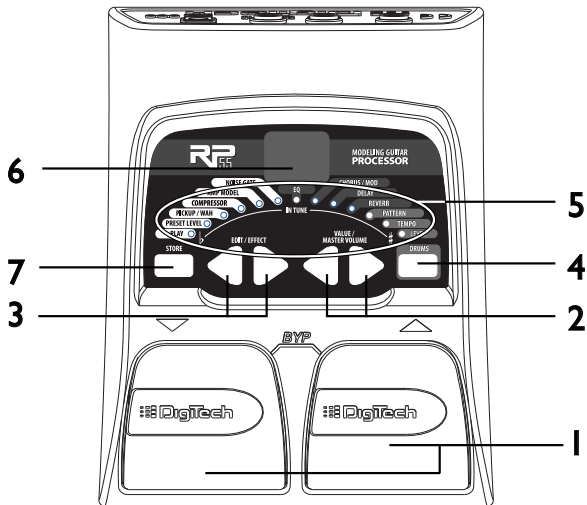

I. Footswitches - These 2 Footswitches are used to select presets, access the Tuner, or bypass the RP55. The Up Footswitch increments, and the Down Footswitch decrements through the presets. Pressing both Footswitches simultaneously bypasses the selected preset. Pressing and holding both Footswitches accesses the Tuner.

- 2. Value Buttons** - The Value Buttons perform various functions depending on which mode is selected. In Play mode, these buttons control RP55's Master Level. In Edit mode, these buttons adjust the selected effect. These buttons also change the Pattern, Tempo, and Level of the Drum machine when it is turned on. When the Tuner is enabled, these buttons select the tuning reference.
- 3. Effect/Edit Buttons** - Pressing either Edit buttons enters Edit mode and selects the individual effects to be edited. Press the left and right Edit buttons to move through the effects. Each effect LED will light to indicate which effect you are editing
- 4. Drums** - The Drums button is used to turn on and off the RP55's drum machine. When the Drums feature is active, the Drums LED lights and the selected drum pattern plays continuously.
- 5. Effect LEDs** - The Effect LEDs provide information regarding the current preset. In Edit mode, the LEDs indicate the effect selected for editing. In Tuner mode, the LEDs indicate whether the note played is sharp, flat, or in tune.
- 6. Display** - The Display provides information for different functions depending on the selected mode. In Play mode, the display shows the selected preset number. In Edit mode, the display shows the value of the parameter being adjusted. When the Tuner is enabled, the display shows the note played.
- 7. Store** - The Store button saves your custom edits to the user presets.

Rear Panel

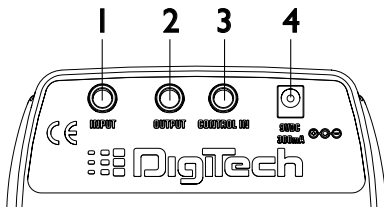

- 1. Input** - Connect your instrument to this jack.
- 2. Output** - This is a stereo TRS jack. Connect from this jack to the input of a single amplifier for mono applications, or use a TRS stereo “Y” cord to connect to the inputs of 2 amplifiers for stereo applications. This jack also can be used as a headphone jack.

Note: When using the RP55 direct into a mixer or recording device, or when using it with headphones, you can enable the **Global Cabinet Modeling** feature to emulate speaker simulation on each of the RP55’s presets. (See Page 20 for more on **Global Cabinet Modeling**.)

- 3. Control In** - Connect a passive mono volume or TS (tip/sleeve) expression pedal to this jack to control Volume, Wah, and Whammy™ in the RP55. TRS expression pedals are not supported.
- 4. Power Input** - Connect only the optional power supply or equivalent to this jack (see Specifications).

Making Connections

There are several different connection options available when using the RP55. The following diagrams show the connections for some of these options.

Before connecting the RP55, make sure that the power to your amplifier is turned off, and the power to the RP55 is disconnected. There is not a power switch on the RP55. To turn the RP55 off, disconnect your instrument from the Input Jack (for battery power) or disconnect the optional power supply from the Power Jack or from the AC outlet.

Mono Operation

Connect your guitar to the Input of the RP55. Connect a single mono instrument cable from the Stereo Output of the RP55 to the instrument input on your amplifier.

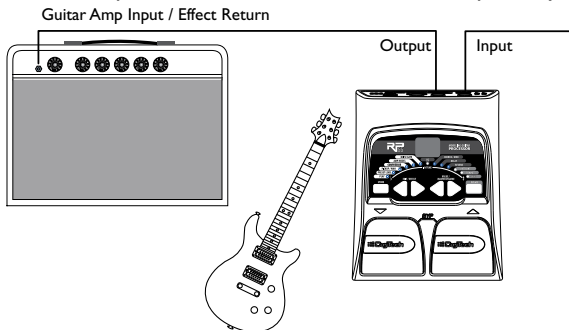

Stereo Operation

For stereo operation connect the guitar to the Input of the RP55. Connect a TRS stereo “Y” cord or a pair of stereo headphones to the RP55’s Output. When using a “Y” cord, connect one end of the “Y” cord to the input of one amplifier or channel of a mixer. Connect the second end of the “Y” cord to a second amplifier, or second channel of a mixer. If connecting to a mixing console, set the pan controls of the mixer hard left and right to retain stereo separation. To emulate a guitar cabinet sound when using the RP55 with a mixer or headphones, you can enable Global Cabinet Modeling (see page 20).

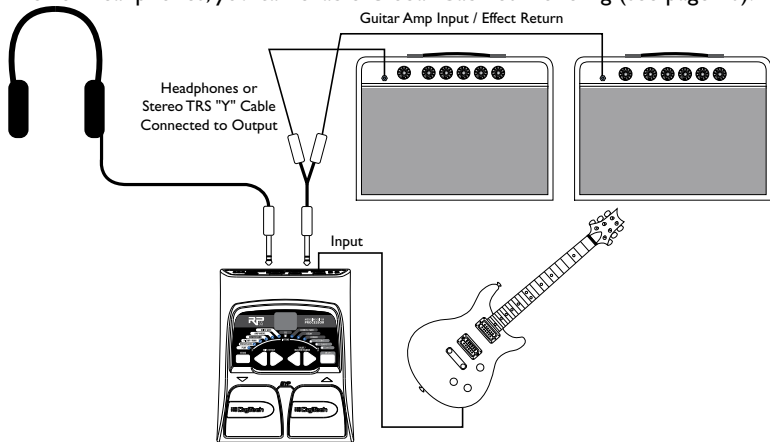

Applying Power

There are two options for powering the RP55: battery power, and the optional DC power supply. Before applying power to anything, set your amp(s) to a clean tone and set the tone controls to a flat EQ response (on most amps, this would be 0 or 5 on the tone controls).

Battery Power

The RP55 can be run for approximately 10 hours on 6 AA batteries. The battery compartment is located on the bottom of the RP55. The following diagram shows how to install the batteries.

Note: Pay close attention to the battery polarity when installing batteries as polarity changes direction for each pair.

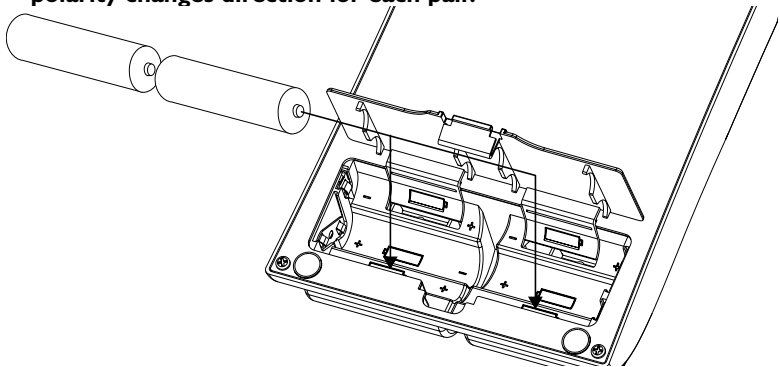

Connecting a cable to the Input applies power to the RP55. Disconnecting your instrument from the Input of the RP55 disconnects the battery power. Turn your amplifier(s) on and adjust the volume(s) to a normal playing level. To prolong the battery life, disconnect your instrument from the RP55's Input when not in use.

AC Power

The RP55 can also be powered with the optional power supply. Connect the plug of the power supply to the power jack on the rear panel of the RP55. Connect the other end of the power supply to an AC outlet. Turn your amplifier(s) on and adjust the volume(s) to a normal playing level.

About the RP55

The Presets

Presets are numbered locations of programmed sounds. Presets are recalled with the Footswitches. The RP55 comes with 40 User Presets (Presets 1-40) and 40 Factory Presets (Presets 41-80). The User Presets are locations where you may store presets you create. The Factory Presets may not be saved over. From the factory, the 40 User Presets are exact duplicates of the 40 Factory Presets. This lets you make your own presets without the worry of losing any Factory Presets.

Play Mode

When you first apply power to the RP55, it powers up in Play mode. The far left LED lights, indicating you're in Play mode. In Play mode, use the Up and Down Footswitches to access the presets.

Tuner

The Tuner in the RP55 lets you quickly tune or check the tuning of your guitar. Enter the Tuner by pressing and holding both Footswitches simultaneously. The E U briefly displays indicating that you are in Tuner mode. To begin tuning, play a note on your guitar (the neck pickup usually works best). The display shows the note being played. The Effect LEDs indicate whether the note is sharp or flat. The right 6 red LEDs indicate the note is sharp and should be tuned down. The left 6 red LEDs indicate the note is flat and should be tuned up. The center Green LED indicates the note is in tune. The output is muted in Tuner mode.

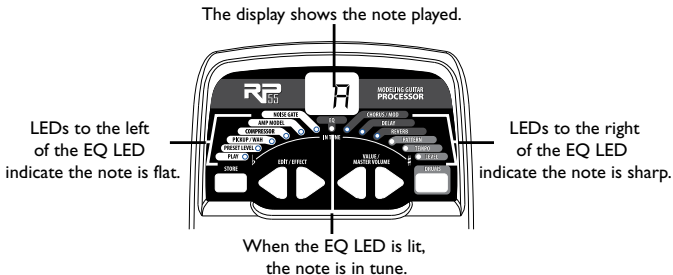

When the Tuner is enabled, you can change your tuning reference. The default factory setting is A=440 Hz. (displayed as 40). Press the Value Buttons to select alternate dropped tunings. Alternate tunings are A = Ab (displayed as $\text{A}b$), A = G (displayed as G), and A = Gb (displayed as $\text{G}b$). The display window briefly flashes the selected tuning preference. Exit

tuner mode by pressing either Footswitch. The tuning reference is retained when the unit is turned off.

Bypass

The RP55 presets can be bypassed for a clean, unprocessed guitar tone. To bypass the RP55, press both footswitches simultaneously. The display reads **bY** indicating the preset is bypassed. Press either footswitch to exit Bypass and return the last selected preset.

Editing/Creating Presets

Creating your own signature sound with the RP55 is easy and intuitive. The RP55 lets you create your own presets, or fine tune existing Presets to suit your needs. When creating or editing a sound, you must start with a User or Factory Preset. It is not possible to start with an empty preset. You can save your preset to any User Preset location while storing the preset (see Storing a Preset pg 12).

To edit or create a Preset:

1. Press the **FOOTSWITCHES** to select a preset
2. Press the **EDIT** buttons in conjunction with the Effect LEDs to choose the effect you want to edit.
3. Press the **VALUE** Buttons to change the parameter values.

The Effect LEDs

When editing a preset, the Effect LEDs are used to indicate which effect is selected for editing. The Edit buttons move you through the Effect modules. The LEDs light indicating which effect group is selected. Each effect has multiple settings to select from. The Value buttons are used to change the value for the selected effect. As a button is pressed, the value or status is shown in the display.

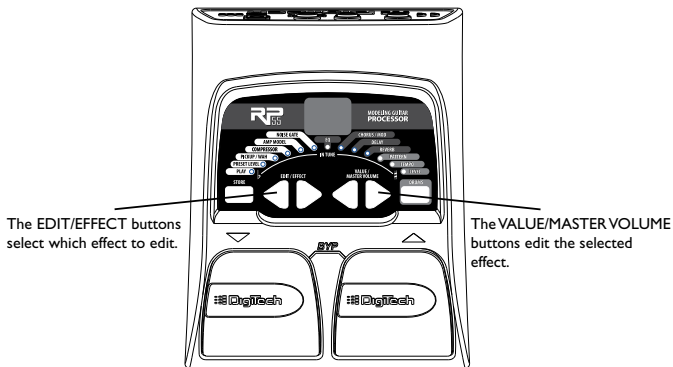

When the stored value of an effect is changed, the lower right decimal point in the display lights indicating you need to store the changes. Changing presets, or turning the power off before storing any changes will erase any changes made and revert to the stored values for the preset.

Storing/Copying a Preset

Once the preset has been modified, you may store your settings to one of the 40 User Preset locations (Presets 1-40). The following steps outline how to store changes to a preset or copy a preset to a different location:

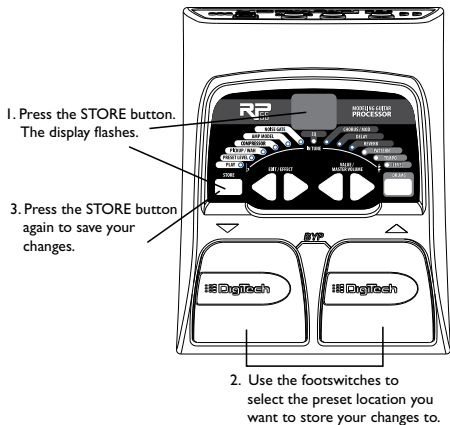

1. Press the **STORE** button once. The current preset location flashes in the display.
2. Press the **FOOTSWITCHES** to select the User Preset location (optional).
3. Press the **STORE** button again to save the changes.

Effect Definitions

The RP55 can be thought of as several different “virtual” amplifiers, and individual hi-tech effects. Each effect within the RP55 can be programmed to suit your personal application. Understanding how these effects alter the sound helps you achieve the sound you are looking for. The following overview of the RP55’s effects outlines what each effect does.

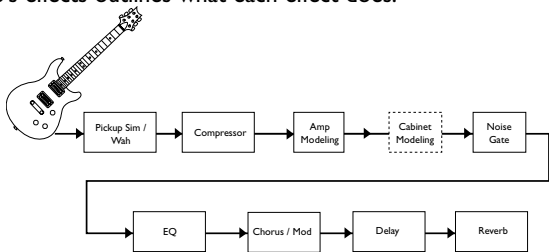

Preset Level

Controls the individual level for each preset. Because this setting is individual to each preset, you may adjust the volume when using louder or softer amp models.

Pickup/Wah

The Pickup Simulator gives the thick tone of a humbucker pickup from a guitar with single coil pickups, or the bright edgy sound of a single coil pickup from a guitar with a humbucker. Wah is an effect controlled by an expression pedal making the guitar sound as if it’s saying “Wah.”

Pickup/Wah Type - The Value buttons select the Pick Up or Wah type that is simulated.

0F - Turns the Pickup Simulator / Wah module off.

5H - Gives a single coil pick up the warm tone of a humbucker.

H5 - Gives a humbucker the unique sound of a single coil.

Cr - Cry Wah is a traditional sounding Wah.

b0 - Boutique Wah is a wider sweeping Wah with a more modern sound.

Fr - Full Range Wah sweeps the entire spectrum of audible frequencies.

Compressor

A Compressor is used to automatically limit the dynamic level of the guitar signal.

1 to *15* - Controls the amount of compression (ratio and sustain) and ranges from 1 (slight compression) through infinity (maximum sustain) or turns the compression effect off.

Amp/Cabinet Modeling

Amp Modeling is a technology that applies the tones of several popular modern and vintage amps and acoustic guitar simulation. Values 1-9 increase the amp's gain and level.

b 1-b9 - Based on a Blackface

0 1-09 - Based on Boutique

r 1-r9 - Based on a Rectifier

H 1-H9 - Based on a Hot Rod

t 1-t9 - Based on a Classic Tweed

C 1-C9 - Based on a British Combo

c 1-c9 - Based on a Clean Tube amp

S 1-S9 - Based on a British Stack

U 1-U9 - A nice crunchy tube combo

G 1-G9 - Based on High Gain tube amp

F 1-F9 - A vintage fuzz distortion

AC - A flat top acoustic guitar

Any trademarks are the property of their respective companies and are in no way associated with DigiTech.

EQ

Equalization is used to shape the tonal response of your guitar signal. The EQ in the RP55 is similar to the tone knobs on an amplifier. Values 1-4 cut the level of each band, 5 is flat (no cut or boost), and values 6-9 boost the level of each band.

Bass (b 1- b9) - The Value buttons adjust the amount of low end enhancement (Bass).

Mid (d 1- d9)- The Value buttons adjust the amount of mid range enhancement.

Treble (t 1- t9)- The Value buttons adjust the amount of high end enhancement (Treble).

Noise Gate

A Noise Gate is designed to eliminate noise while you are not playing. The AutoSwell setting creates a volume pedal effect automatically with varying attack times. Different guitars and pickups require different threshold settings. Choose a setting that fully mutes the sound when you are not playing for the lowest setting.

⓪ 1-⓪9 - Selects the Silencer™ Noise Gate. Settings 1-9 select the threshold. Of turns the gate effect off.

Ⓢ 1-Ⓢ9 - Selects the Auto Swell volume swell effect. Settings 1-9 select the attack time.

Chorus/Mod

The Chorus/Mod module is a multi-function module that lets you select the following effects: Chorus, Flanger, Phaser, Tremolo, Panner, Vibrato, Rotary Speaker, AutoYa™, Envelope Filter, Detune, Pitch Shift, and Whammy™ effects. When the Chorus/Mod module is selected, the Value buttons are used to choose the type of effect. Only one of the effects in this row can be used at a time. The following list describes each effect and their parameters in more detail.

Chorus (C 1-C9)

A Chorus adds a short delay to your signal. The delayed signal is modulated in and out of tune and then mixed back with the original signal to create a thicker sound, and stereo image. Use the Value buttons to select one of the nine Chorus settings.

Flange (F 1-F9)

A Flanger uses the same principle as a Chorus but uses a shorter delay time and adds regeneration (or repeats) to the modulating delay. This results in an exaggerated up and down sweeping motion to the effect. Use the Value buttons to select one of the nine Flanger settings.

Phaser (P 1-P9)

A phaser splits the incoming signal, and changes the phasing of the signal. The signal is taken in and out of phase and mixed back in with the original signal. As the phasing changes, different frequencies get canceled resulting in a warm sort of twisting sound. Use the Value buttons to select one of the nine Phaser settings.

Tremolo (T 1-T9)

A Tremolo effect modulates the volume of the signal at an even rate. Use the Value buttons to select one of the nine predetermined settings.

Panner (n 1-n9)

An Auto Panner modulates the sound from left to right at an even rate. Use the Value buttons to select one of the nine Panner settings.

Vibrato (b 1-b9)

A Vibrato effect modulates the pitch of the incoming signal at an even rate. Use the Value buttons to select one of the nine Vibrato settings.

Rotary Speaker (r 1-r9)

Rotary Speaker is an emulation of a device that included a spinning horn and woofer. The rotation of these two speakers produces an interesting combination of sound panning from side to side with a slight pitch change produced from the speed of the sound coming towards, and then going away from the listener. Use the Value buttons to select one of the nine Rotary Speaker settings.

AutoYa™ (A 1-A9)

An AutoYa™ combines the characteristics of a Wah and a Flanger together creating an almost human vowel characteristic as if the guitar were saying “Yah.” The AutoYa™ provides animation to the sound based on string attack. Use the Value buttons to select one of the nine AutoYa™ settings.

Envelope Filter (E 1-E9)

The Envelope Filter is a dynamic Wah effect that alters your sound based upon how hard you play. Use the Value buttons to select one of the nine Envelope Filter settings.

Detune (d 1-d9)

A Detuner makes a copy of your incoming signal, takes the copied signal slightly out of tune from the original, and mixes the two signals together. The result is a doubling type

of effect as if two guitars were playing the same part together. Use the Value buttons to select one of the nine Detuner settings.

Pitch Shift (H 1-H9)

The Pitch Shifting copies the incoming signal, and shifts the pitch of the copy to a different note. The shifted note is mixed back with the original signal sounding as if two guitars were playing different notes. Use the Value buttons to select one of the nine Pitch Shift settings. The Pitch Shift settings are as follows:

H 1= -12 semitones

H 2= -7 semitones

H 3= -5 semitones

H 4= -4 semitones

H 5= +3 semitones

H 6= +4 semitones

H 7= +5 semitones

H 8= +7 semitones

H 9= +12 semitones

Whammy™ (Y 1-Y9)

Whammy™ is an effect that uses an Expression Pedal to bend the pitch of the incoming signal, or add a bendable harmony with the original signal. As the Pedal is moved, the note bends either up or down. Use the Value buttons to select one of the nine Whammy™ settings. **W** denotes Whammy bends and **H** denotes harmony bends. The Whammy settings are as follows:

Y 1=**W** Octave Up

Y 2=**W** 2 Octaves Up

Y 3=**W** Octave Down

Y 4=**W** 2 Octaves Down

Y 5=**H** m3rd/Maj 3rd Up

Y 6=**H** 2nd/Maj 3rd Up

Y 7=**H** 3rd/4th Up

Y 8=**H** Octave Up

Y 9=**H** Octave Down

Delay

The RP55 has 3 different delay types, Digital (D), Analog (A), and Ping Pong (P), each with up to 2 seconds of delay time available. There are two different parameters used to program the delay, Delay Variation and Time. The first parameter of the delay effect is Delay Type/Variation, which selects the delay type to be used and varies the amount of feedback (number of repeats) and level. The second delay parameter is Delay Time. This is indicated by a value 1-99 (10ms-990ms), 1.0 and 2.0 (1 and 2 seconds respectively) in the display when the Delay LED is lit. Delay settings are as follows:

D, A, P 1=5% fback, level 15	D, A, P 4=5% fback, level 30	D, A, P 7=5% fback, level 50
D, A, P 2=25% fback, level 15	D, A, P 5=25% fback, level 30	D, A, P 8=25% fback, level 50
D, A, P 3=50% fback, level 15	D, A, P 6=50% fback, level 30	D, A, P 9=50% fback, level 50

Reverb

Using reverb in recorded program material gives the listener a sense that the material is being performed in an actual room or hall. It is this similarity to actual acoustic spaces that makes reverberation a useful tool in recorded music. Use the Value buttons to select one of the nine predetermined settings. The higher numbers indicate there is more reverb level. The reverb settings are as follows:

R 1-19 = Room

H 1-19 = Hall

P 1-19 = Plate

C 1-19 = Church

A 1-19 = Arena

S 1-19 = Spring

Other Functions

Expression Pedal

The rear panel of the RP55 includes an input for an expression pedal. Any passive mono volume or TS (tip/sleeve) expression pedal can be used as an expression pedal with the RP55. TRS expression pedals are not supported. Connect from the output of a supported volume or expression pedal to the Expression Pedal Input on the RP55. The expression pedal controls the RP55's Volume, Wah, or Whammy™ parameters. If Wah and Whammy are disabled, the expression pedal functions as a volume pedal. If the Wah or Whammy™ effects are enabled, the expression pedal will control these effects.

Drum Machine

The RP55 includes several sampled drum patterns that are useful for developing a good sense of timing. Press the Drums button to enter Drums mode and start playback of the drum loop (except when in Store or Bypass mode). In Drums mode, the Edit buttons selects the drum Pattern, Tempo, and Level of the drum loop. Press the Drums button again to stop playback of the drum loop.

Global Cabinet Modeling

The RP55 includes cabinet modeling that can be enabled on all presets when running it into a mixer, recording device, or when using it with headphones. This feature emulates a speaker cabinet connected to each of the amp models in all presets. Each amp model has a specific cabinet model that optimizes its sound when using the RP55 in this manner. To enable Cabinet Modeling:

1. Press and hold the drums button when applying power to the RP55. Wait until the display reads `CRB inEt 0n`. Release the Drums button.

Cabinet Modeling is now enabled for all amp models in all presets. The following lists what cabinet accompanies each model:

- b* | *b9* – Blackface – 2x12 Cabinet
- o* | *o9* – Boutique – Vintage 4x12 Cabinet
- r* | *r9* – Rectifier – Vintage 4x12 Cabinet
- H* | *H9* – Hot Rod – British 4x12 Cabinet
- t* | *t9* – Classic Tweed – 2x12 Cabinet
- l* | *l9* – British Combo – 2x12 Cabinet
- c* | *c9* – Clean Tube – British 4x12 Cabinet
- S* | *S9* – British Stack – British 4x12 Cabinet
- U* | *U9* – Crunch – Vintage 4x12 Cabinet
- G* | *G9* – High Gain Tube – British 4x12 Cabinet
- F* | *F9* – Fuzz – British 4x12 Cabinet

Factory Reset

This function resets the RP55 to its original factory settings. This procedure erases all custom user presets. **Performing this function erases all user-programmed data. All such data will be lost forever!**

The procedure for performing a Factory Reset is as follows:

1. Disconnect the power supply from the RP55 (AC Power) or unplug the guitar from the input jack (battery power).
2. Press and hold the left **EDIT** button while re-connecting the power or plugging your guitar into the RP55's input.
3. When the display reads --, release the button and press the **STORE** button. The display reads *rE*. The RP55 is now restored to its factory settings.

Appendix

Specifications:

Input: 1/4" input

Output: 1/4" Stereo TRS (can be used as a headphone output)

Control In: 1/4" input – Use a passive mono TS (tip/sleeve) expression or volume pedal as an expression controller

Power Consumption: 5 Watts Maximum (w/ optional power supply)

Battery Life: ~10 hours with continuous usage

A/D/A: 24 bit Delta Sigma

Memory: 40 User/40 Factory Presets

Effects: Pickup Simulator, Wah, Compressor, 11 Amp Models, Acoustic Guitar Simulator, 3 band EQ, Noise Gate, Cabinet Modeling, Chorus, Flange, Phaser, Tremolo, Panner, Vibrato, Rotary Speaker, Auto Ya™, Envelope Filter, Pitch Shift, Detune, Whammy™, Delay, and Reverb

Drum Machine: 30 Patterns

Simultaneous Effects: up to 8

Dimensions: 5.65" L x 6.5" W x 2.5"H

Weight: 1 lb (2 lbs. w/ power supply)

Power Supply: 6 AA Batteries or optional 9VDC power supply.

***IMPORTANT NOTE:** Use only the correct power supply according to the Voltage in your Country (see below table).

Country (Voltage)	Compatible PSU Model		
Japan (100 VAC, 50/60 Hz):	PS200R-100*	or	PS0913DC-01*
US and Canada (120 VAC, 60 Hz):	PS200R-120*	or	PS0913DC-01*
Europe (230 VAC, 50 Hz):	PS200R-230*	or	PS0913DC-01*
UK (240 VAC, 50 Hz):	PS200R-240*	or	PS0913DC-02*
Australia (240 VAC, 50 Hz):	PS200R-240-AU*	or	PS0913DC-02*

Power Supply Specs		
Model	Output	Polarity
PS200R:	9VDC 300 mA	⊕ — ⊖
PS0913DC:	9VDC 1300 mA	⊕ — ⊖

Preset List (User/Factory)

1/41	Stacked	21/61	Bad Dog
2/42	Recto Delay	22/62	Steely Phase
3/43	Clean Chorus	23/63	Rhythm Crunch
4/44	Octave Drive	24/64	Metal Scoop
5/45	Classic Blackface	25/65	Slap Rhythm
6/46	Crunchy Phase	26/66	20 Fathoms
7/47	Fuzz Church	27/67	Electro-Sitar
8/48	Grindy Detune	28/68	Smooth Drive
9/49	Big Boutique	29/69	Fuzzboy
10/50	Acoustic Chorus	30/70	Surfin'
11/51	Sustainium	31/71	Clean Flange
12/52	Rotary Blues	32/72	Thickerer
13/53	Wahtch It	33/73	Pedal Steel
14/54	Power Flange	34/74	Short Stack
15/55	Campfire Tremolo	35/75	Dirt Combo
16/56	Detune Tube	36/76	Triplet Chunk
17/57	Whammy Time	37/77	Roto Jazz
18/58	Mr. Guts	38/78	Acoustic 5ths
19/59	Ottowah	39/79	Ya Ya Sure
20/60	Volume Swell	40/80	Octavian

DigiTech
8760 South Sandy Parkway
Sandy, Utah 84070
PH (801) 566-8800
FAX (801) 566-7005

**DigiTech® is a registered trademark
of Harman**

Copyright - Harman

Printed in China

RP55 Modeling Guitar Processor
Owner's Guide 18-0838V-A

**Please visit DigiTech
on the World Wide Web at:
www.digitech.com**

